



neptronic®

Multi-Steam™ SD/HD

SKD-M Series

Direct Steam Injection Humidifier

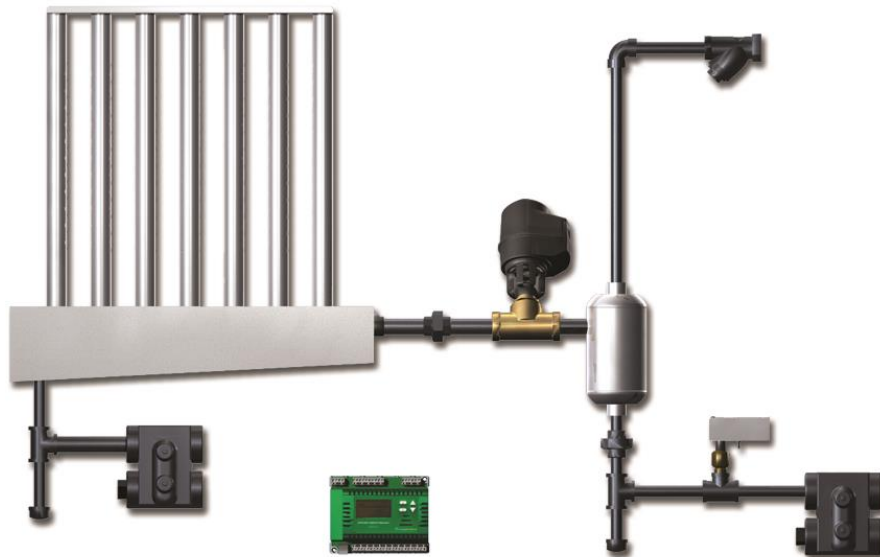

Installation Instructions and User Manual

For the following configuration:

- Multi-Steam™ SD (Standard)
- Multi-Steam™ HD (with X-Stream™ Technology)

READ AND SAVE THESE INSTRUCTIONS

Foreword and Safety Instructions

Neptronic Company Overview

Founded in 1976, we're a private corporation that designs, manufactures and distributes products for the HVAC industry. Our product line includes intelligent controllers, electronic actuators, actuated valves, humidifiers and electric heaters.

Our products are designed and manufactured by over 250 dedicated employees in our 7,500 m² (80,000 ft²) state-of-the-art facility located in Montreal, Canada. Using a vertical integration model, our entire manufacturing chain is under one roof from software and hardware development, to SMT circuit board assembly, to sheet metal fabrication, to product testing ensuring that our products are engineered to last.

We currently hold several national and international patents and with our continued commitment to research and development, we provide innovative products and technologies for the ever-evolving challenges of the HVAC industry. Exporting over 70% of our sales, we have an exclusive distribution network around the globe that provides comprehensive solutions to our worldwide customers.

About the Manual

These installation and operation instructions have been developed to facilitate the installation of the Multi-Steam™ SD/HD.

- The strict application of these instructions will ensure the conformity of your installation and operation as per the manufacturer's recommendations.
- The application of these instructions is one of the conditions for the application of the warranty.
- The application of these instructions does not ensure, at any time conformity to procedures, regulation or local codes, regarding electric installation and connection to local water supply.

This product has been declared to conform to the applicable Canadian and American safety standards and directives and bear the CSA (c) & (us) mark. The Certificate of Conformity CSA is available, upon request with the manufacturer.

2018©: All rights reserved. This document cannot be reproduced totally or partially by any means whether, electronic, mechanical, photocopy, recording or other, without prior written authorization of Neptronic.

Electricity



All work concerned with electrical installation **MUST** only be performed by skilled and qualified technical personnel such as an electrician or a technician with appropriate training). The customer is always responsible for ensuring the suitability of the technical personnel.

Please observe the local regulations concerning the provision of electrical installations.

Correct Use

Neptronic systems and its products are designed only for humidification use. Any other application is not considered appropriate for the intended purpose. The manufacturer cannot be made liable for any damage resulting from incorrect use.

General Warranty

This product is subject to the terms and conditions described at <http://www.neptronic.com/Sales-Conditions.aspx>.

List of Illustrations

Illustration 1 - X-Stream and Standard Steam Distributor	4
Illustration 2 - Components Overview	6
Illustration 3 - Installation Stages Overview	8
Illustration 4 – Steam Distribution System Installation	9
Illustration 5 - Manifold Installation: Front View.....	10
Illustration 6 - Manifold Installation: Side View.....	10
Illustration 7 - Header Mounting Brackets and Steam	10
Illustration 8 - Steam Control Valve Installation	11
Illustration 9 - Flow Direction, Steam Control Valve.....	11
Illustration 10 - Tilt Angle, Steam Control Valve.....	11
Illustration 11 - Steam Separator Installation.....	13
Illustration 12 - Correct Installation	13
Illustration 13 - Incorrect Installation	13
Illustration 14 - Temperature Sensor Installation.....	14
Illustration 15 - Float and Thermostatic Steam Trap Installation	14
Illustration 16 - Correct distance between Temperature Sensor and Steam Trap.....	15
Illustration 17 - Strainer Installation	15

Contents

Technical Specifications	4
Product Description	4
Handling and Packing	7
Handling and Lifting	7
Unpacking	7
Installation Overview	8
Installation Method Statement.....	8
Stage 1 – Steam Dispersion Grid and Header Installation	9
Stage 2 – Steam Control Valve (AM060) Installation.....	11
Stage 3 – Steam Separator Installation.....	13
Stage 4 – Temperature Sensor Installation.....	14
Stage 5 – Float and Thermostat Steam Trap Installation.....	14
Stage 6 – Strainer Installation	15
Stage 7 – Electronic Steam Controller (SKDESC-M)	16
Initial Verification.....	28
Installation	28
Electrical.....	28
Drain if Required	28
Steam Supply	28
Controls.....	28
Start-Up Procedure	29
Start-up	29
Safety Test.....	29
Reset the Setpoint and Control Mode	29
End	29
Notes.....	30

Technical Specifications

Product Description

The Direct Steam Injection Humidifier injects and disperses atmospheric or low pressure steam into a building's air supply system to attain and maintain the desired humidity level. It uses steam from an in-house boiler to humidify the air. The Direct Steam Injection Humidifier is available in two configurations.

- Multi-Steam™ SD (Standard)
- Multi-Steam™ HD (with X-Stream™ Technology)

The Multi-Steam™ HD is combined with X-Stream™, a high efficiency insulated steam distributor that increases the performance of the humidifier and provides an ideal solution for atmospheric and low pressure steam applications. The Multi-Steam™ SD (Standard) is the standard variation that offers all the unique features of the Direct Steam Injection Humidifier except the X-Stream™ technology. The following illustration indicates the difference between the X-Stream™ and standard steam distributor.

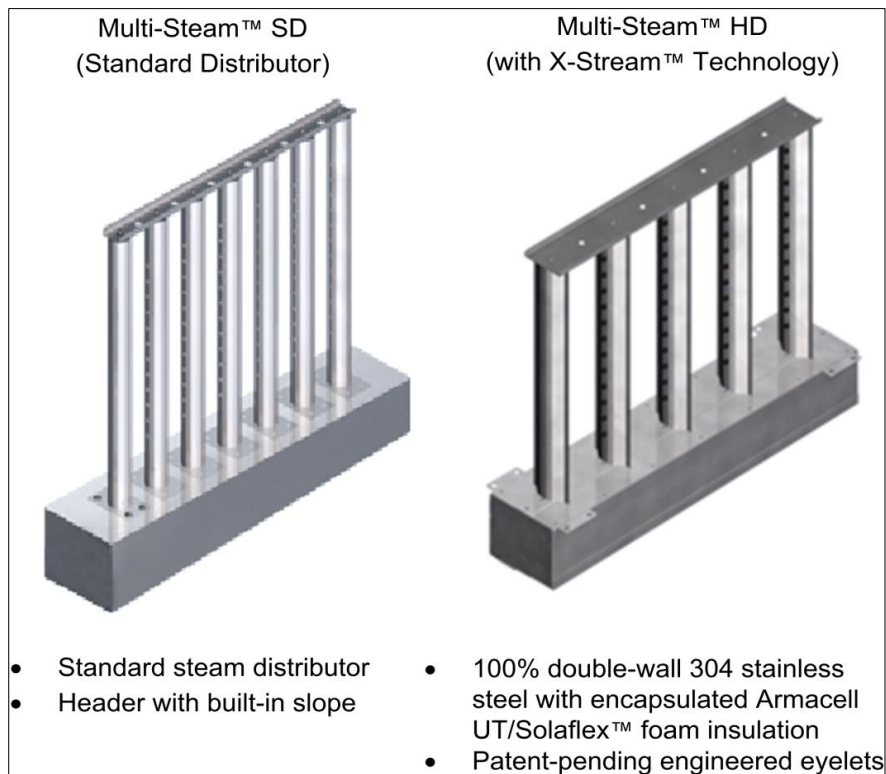

Illustration 1 - X-Stream and Standard Steam Distributor

The Multi-Steam™ SD/HD is controlled by an Electronic Steam Controller (SKDESC-M) that has been specifically designed to control and operate the humidifier. It comes with user-friendly features such as easy start-up and diagnostics, large LCD display, simple configuration options, and factory configured settings. It controls the sequence of operations to optimize energy efficiency and prevent condensate ejection.

The following are the features of the Multi-Steam™ SD/HD and their functions:

- *Multi-Steam Distribution System.* The steam dispersion grids are made with stainless steel (1 3/8") [35mm]. The Multi-Steam Distribution consists of multiple vertical dispersion grids mounted on a single horizontal header. Upon a demand for humidity, the ESC controller slowly opens the steam-modulating valve feeding steam to the dispersion grids through a single horizontal header. The steam escapes the dispersion system through multiple eyelets on the vertical grids and mixes with the airflow to maintain the desired humidity level. The Multi-Steam™ SD/HD is the most energy efficient steam injection system and provides drain-free operations.
- *X-Stream™ Technology.* The Multi-Steam™ HD comes with X-Stream™ technology, a high efficiency insulated steam distributor that enhances the functioning of the humidifier and reduces energy wastage up to 85%, airstream heat gain, and generated condensate.
- *Steam Separator.* Constructed with stainless steel, the separator supplies condensate-free steam to the steam control valve and discharges condensate to the steam trap.
- *Control Valves.* The humidifier comes with normally closed globe valve with equal percentage flow characteristics to control the flow of steam. It comes in variants such as bronze body and brass trim (stainless steel trim optional). The linear electric actuator (AM060) is equipped with a heat shield. The control valves provide full modulation of the low-pressure steam flow for a better control of the humidity level.
- *Electronic Steam Controller (SKDESC-M).* The ESCM is a microprocessor based steam controller equipped with a backlit LCD display that allows programming the humidity setpoints and monitoring parameters such as actual humidity, airflow switch, interlock, temperature sensors efficient and easy.
- *Strainer.* The strainer strains foreign matter from pipelines and protects the components of the steam humidifier.
- *RTD Temperature Sensors.* The Multi-Steam™ SD/HD comes with RTD temperature sensors integrated in a brass thermowell. The temperature sensors monitor steam temperature and detect abnormal condensate levels to ensure safe operations.
- *Float and Thermostatic Steam Trap.* The design comes with the universal four-port design, all stainless steel internal components with the option of a stainless steel body construction as well. The Float and thermostat eliminates condensate from the steam line.

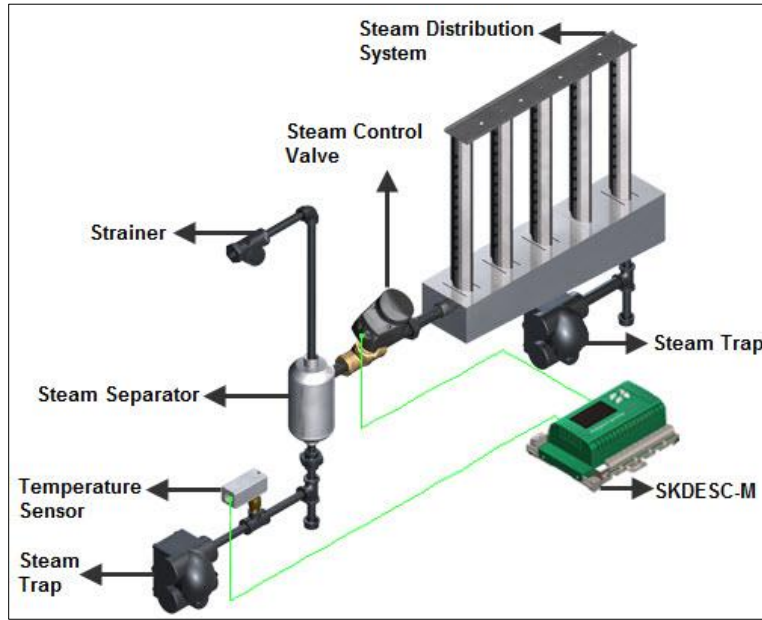

Illustration 2 - Components Overview

Handling and Packing

Handling and Lifting



Lifting or handling **MUST** be carried out by trained and qualified personnel. Ensure that the lifting operation has been properly planned, assessed for risk and that the equipment has been checked by a competent Health & Safety representative, and effective control measures are in place.

It is the customer's responsibility to ensure that the operators are trained in handling heavy goods and to enforce the relevant lifting regulations.

The Multi-Steam™ SD/HD **MUST** always be handled and lifted with care and must remain in its original packaging for as long as possible prior to installation.

The Multi-Steam™ SD/HD package may be carried using a forklift from the underside. Caution must be exercised to ensure balanced load before lifting.

Unpacking

The Multi-Steam™ SD/HD is shipped inside carton boxes or in a wooden crate. Remove packing and skids prior to commissioning.

Installation Overview



All installation work must comply with local regulations.

All work related to the installation of the Multi-Steam™ SD/HD MUST only be performed by skilled and qualified technical personnel such as plumbers or technicians with appropriate training. The customer is responsible for ensuring their suitability.

For the installation of the Multi-Steam™ SD/HD and associated components, there are no specific tooling requirements.

Installation Method Statement

Stage 1 – Steam Dispersion Grids and Header Installation

Stage 2 – Steam Control Valve (AM060) Installation

Stage 3 – Steam Separator Installation

Stage 4 – Temperature Sensor Installation

Stage 5 – Float and Thermostat Steam Trap Installation

Stage 6 – Strainer Installation

Stage 7 – Electronic Steam Controller (SKDESC-M)

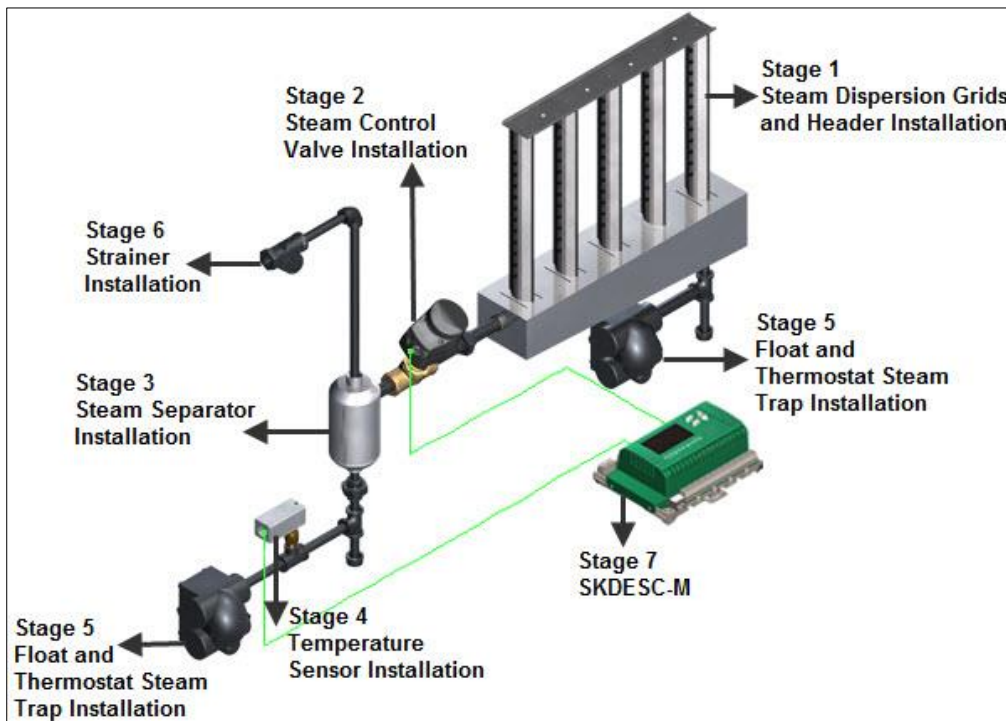

Illustration 3 - Installation Stages Overview

Stage 1 – Steam Dispersion Grid and Header Installation

General Considerations



Any installation work must be carried out by suitably qualified personnel.

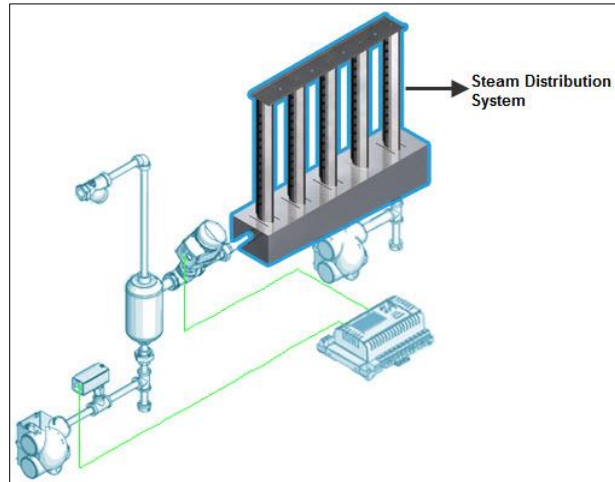

Illustration 4 - Steam Distribution System Installation

Consider the following points before deciding the location for the Multi-Steam™ SD/HD steam distribution system:

Positioning Steam Dispersion

- Plan a location that is easy to access and permits an easy inspection and servicing of the humidifier.
- Steam nozzles must face the airflow to minimize the absorption and non-wetting distance.
- Do not install the humidifier where failure of the appliance could cause damage to the building structure or to other expensive equipment.
- Verify that the construction of the duct or AHU wall is suitable to support the steam distributors through the duration of the installation life.

Positioning the Header Assembly

- Locate the steam distributors assembly far enough from elbow or fan to be in laminar air flow to ensure proper evaporation distance.
- There must be sufficient straight duct downstream from the steam distributors for absorption of the steam.
- Position the assembly so that the distances between both sides are the same.

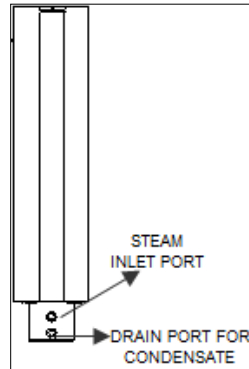

Illustration 5 - Manifold Installation: Front View

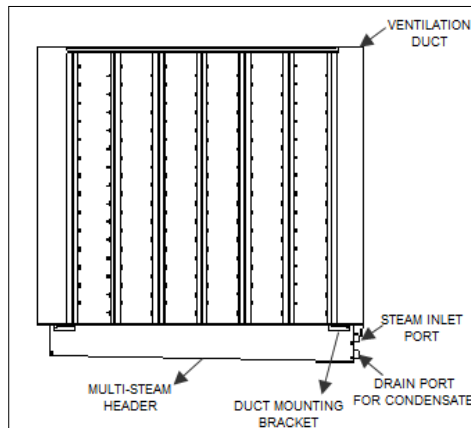

Illustration 6 - Manifold Installation: Side View

- For insertion type, secure the header on the bottom of the duct with metal screws.
- Secure the top of the assembly by bolting the perforated top mounting plate to the ventilation duct or AHU.
- Use the duct bottom mounting brackets to secure the header underneath the duct.

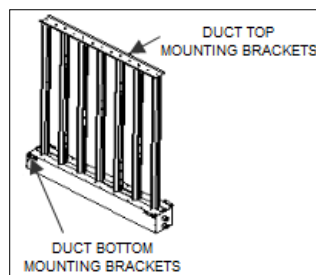

Illustration 7 - Header Mounting Brackets and Steam

Stage 2 – Steam Control Valve (AM060) Installation



Any installation work must be carried out by suitably qualified personnel.

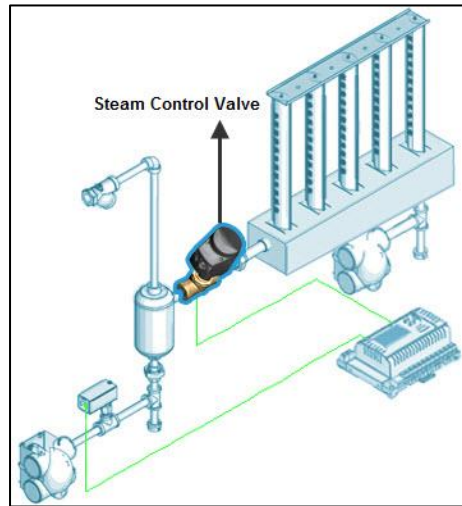

Illustration 8 - Steam Control Valve Installation

Positioning the Control Valve

- Install the actuated valve (AM060 actuator with globe valve) between 20 to 30 degrees from vertical in order to reduce the convection heat to the actuator.

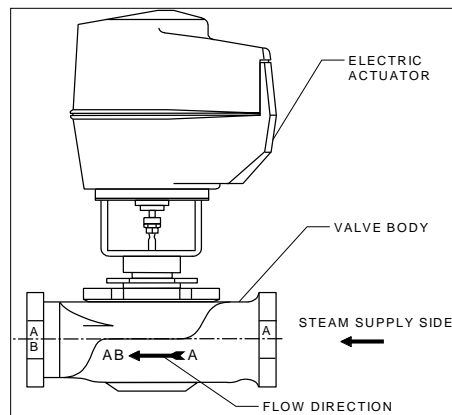

Illustration 9 - Flow Direction, Steam Control Valve

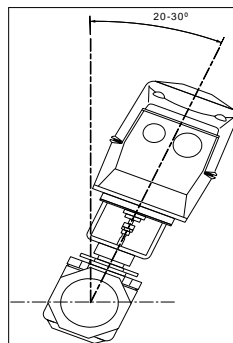

Illustration 10 - Tilt Angle, Steam Control Valve

Control Valve Flow Coefficient and Capacity

Valve Size	Cv (Kv)	Separator Size	Steam Capacity (lb/h) [kg/h]			
			2 PSI (14kPa)	5 PSI (35kPa)	10 PSI (69kPa)	15 PSI (103kPa)
1/2" (DN15)	0.4 (0.3)	3/4" (DN20)	7 [3]	12 [5]	14 [7]	17 [8]
	1.3 (1.1)		22 [10]	38 [17]	47 [21]	54 [24]
	2.2 (1.9)		37 [17]	65 [29]	79 [36]	91 [41]
	4.4 (3.8)		73 [33]	129 [59]	158 [72]	182 [83]
3/4" (DN20)	5.5 (4.8)	1" (DN25)	92 [42]	161 [73]	198 [90]	227 [103]
	7.5 (6.5)		125 [57]	220 [100]	270 [123]	310 [141]
1" (DN25)	10 (8.7)	1 1/2" (DN40)	167 [76]	293 [133]	360 [164]	413 [188]
	14 (12)		233 [106]	411 [187]	504 [229]	579 [263]
1 1/4" (DN30)	20 (17)		333 [152]	587 [267]	720 [327]	827 [376]
1 1/2" (DN40)	28 (24)		467 [212]	821 [373]	1008 [458]	1157 [526]
2" (DN50)	40 (35)	2" (DN50)	667 [303]	1173 [533]	1440 [655]	1653 [752]

Stage 3 – Steam Separator Installation



Any installation work must be carried out by suitably qualified personnel.

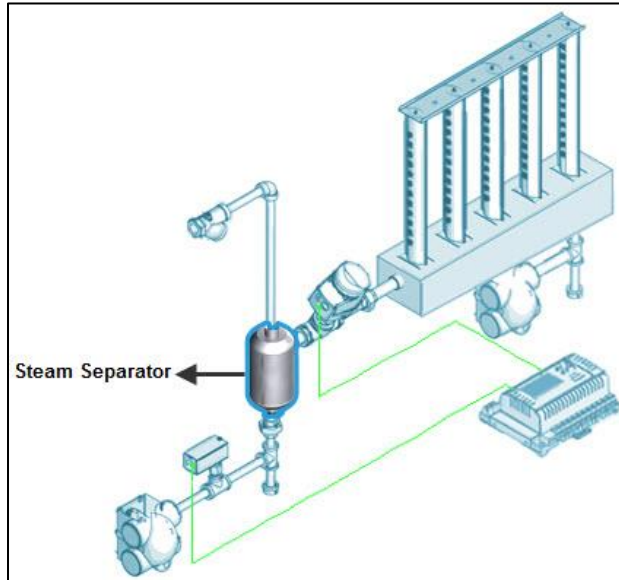

Illustration 11 - Steam Separator Installation

Positioning the Steam Separator

Install the steam separator so that the steam inlet is on the top and the steam outlet is on the side. Condensate outlet must point vertically down.

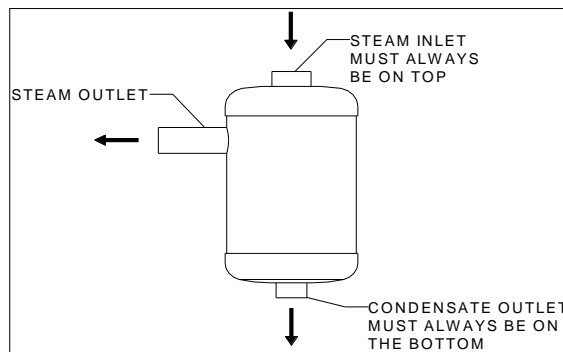

Illustration 12 - Correct Installation

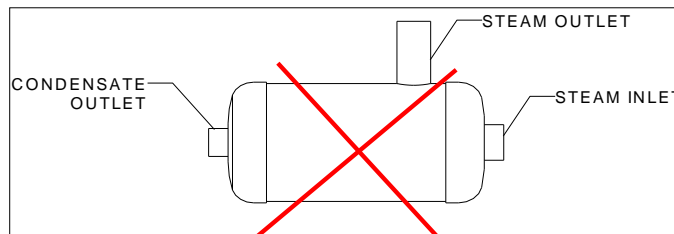

Illustration 13 - Incorrect Installation

Stage 4 – Temperature Sensor Installation



Any installation work must be carried out by suitably qualified personnel.

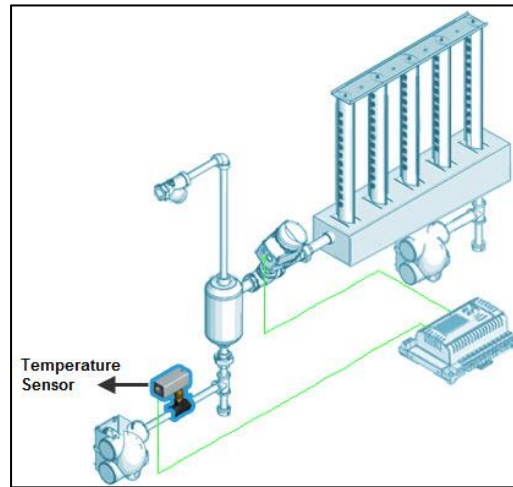

Illustration 14 - Temperature Sensor Installation

Installing the Temperature Sensor

- The Multi-Steam™ SD/HD requires only one temperature sensor.
- Install the temperature sensor upstream the control valve and downstream the steam separator.

Stage 5 – Float and Thermostat Steam Trap Installation



Any installation work must be carried out by suitably qualified personnel.

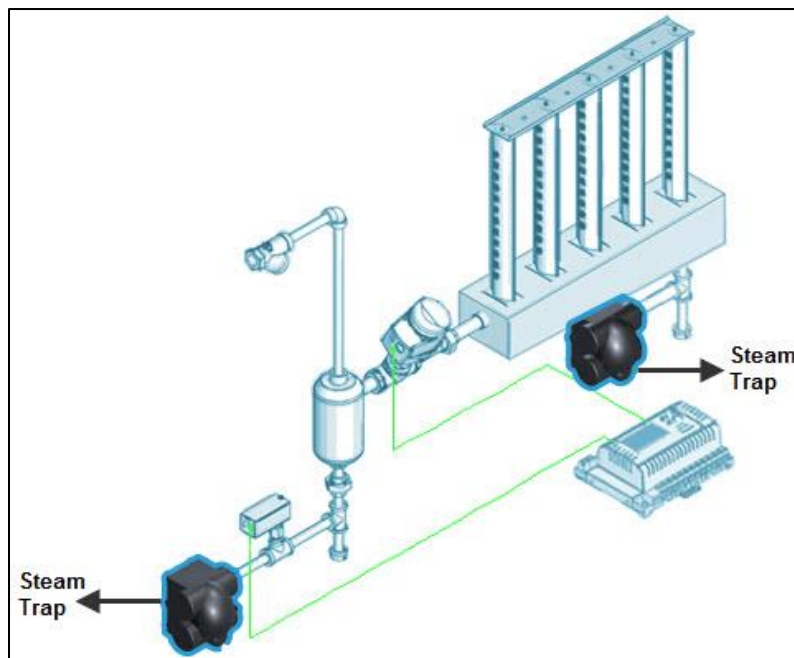

Illustration 15 - Float and Thermostatic Steam Trap Installation

Installing Float and Thermostatic Steam Trap

- The Multi-Steam™ SD/HD system requires installation of at least one float and thermostatic steam trap. Install it downstream the temperature sensor.
- Connect the float and thermostatic steam trap inlet to the temperature sensor using a single nipple.
- Connect the float and thermostat steam trap outlet to the condensate return line.
- The distance between the temperature sensor and the steam trap must be between 5 and 7" (100-175 mm).

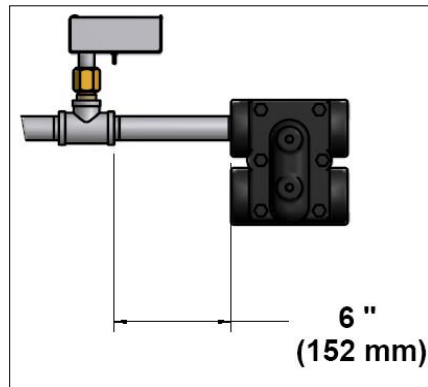

Illustration 16 - Correct distance between Temperature Sensor and Steam Trap

- Connect a float and thermostat steam trap or a P-trap to the header condensate outlet.

Stage 6 – Strainer Installation



Any installation work must be carried out by suitably qualified personnel.

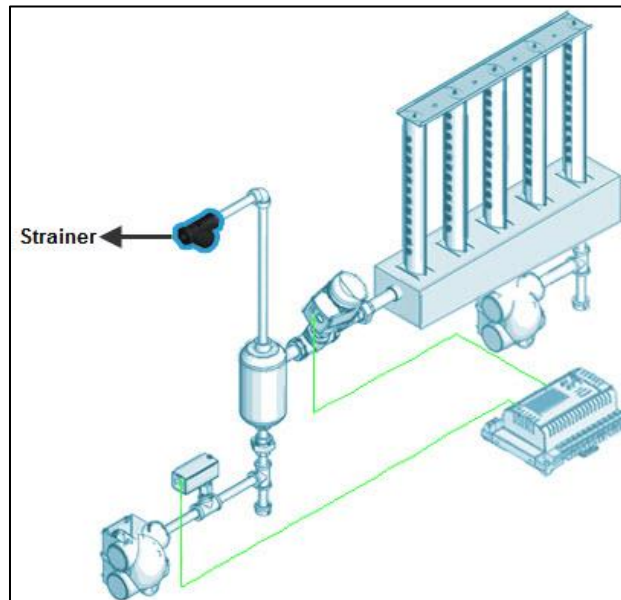

Illustration 17 - Strainer Installation

Install the strainer within six linear feet from the steam separator reducing the pipe length for the strainer and the first Multi-Steam™ SD/HD component.

Stage 7 – Electronic Steam Controller (SKDESC-M)

Models

SKDESC-M

SKDESC-MB with BACnet Communication

SKDESC-MD with Modbus Communication

Description

The Electronic Steam Controller SKDESC-M is made specifically for Neptronic SKD-M (Multi-Steam) Humidifiers.

Features

- Conserves energy and eliminates condensate (dry operation)
 - Manages isolating and modulating valves
 - Pre-heats tube channel jackets only on demand for humidity
- Automatic temperature sensor adjustment
- On/Off or Modulating control
- Selectable internal or external control
- Configurable proportional control band & dead band
- Selectable Fahrenheit or Celsius scale
- BACnet or Modbus models available
- 24 Vac power supply (by others)
- Easy start up and troubleshooting
- Backlit LCD with simple icon and text driven menus



ESC Steam Controller Series

Technical Specifications

Description	SKDESC-M	SKDESC-MB	SKDESC-MD
Power Supply	24 Vac		
Power Consumption	50 VA		
Relay Output	2 relay		
Relay Rating	125 Vac, resistive load 10 amps		
Communication	-	BACnet	Modbus
Operating Temperature	32°F to 122°F (0°C to 50°C)		
Storage Temperature	-22°F to 122°F (-30°C to 50°C)		
Relative Humidity	5 to 95% non-condensing		
Weight	1.4 lb. (635 g)		
Dimensions A = 6.3" 160mm B = 5" 126mm C = 2.25" 57mm			



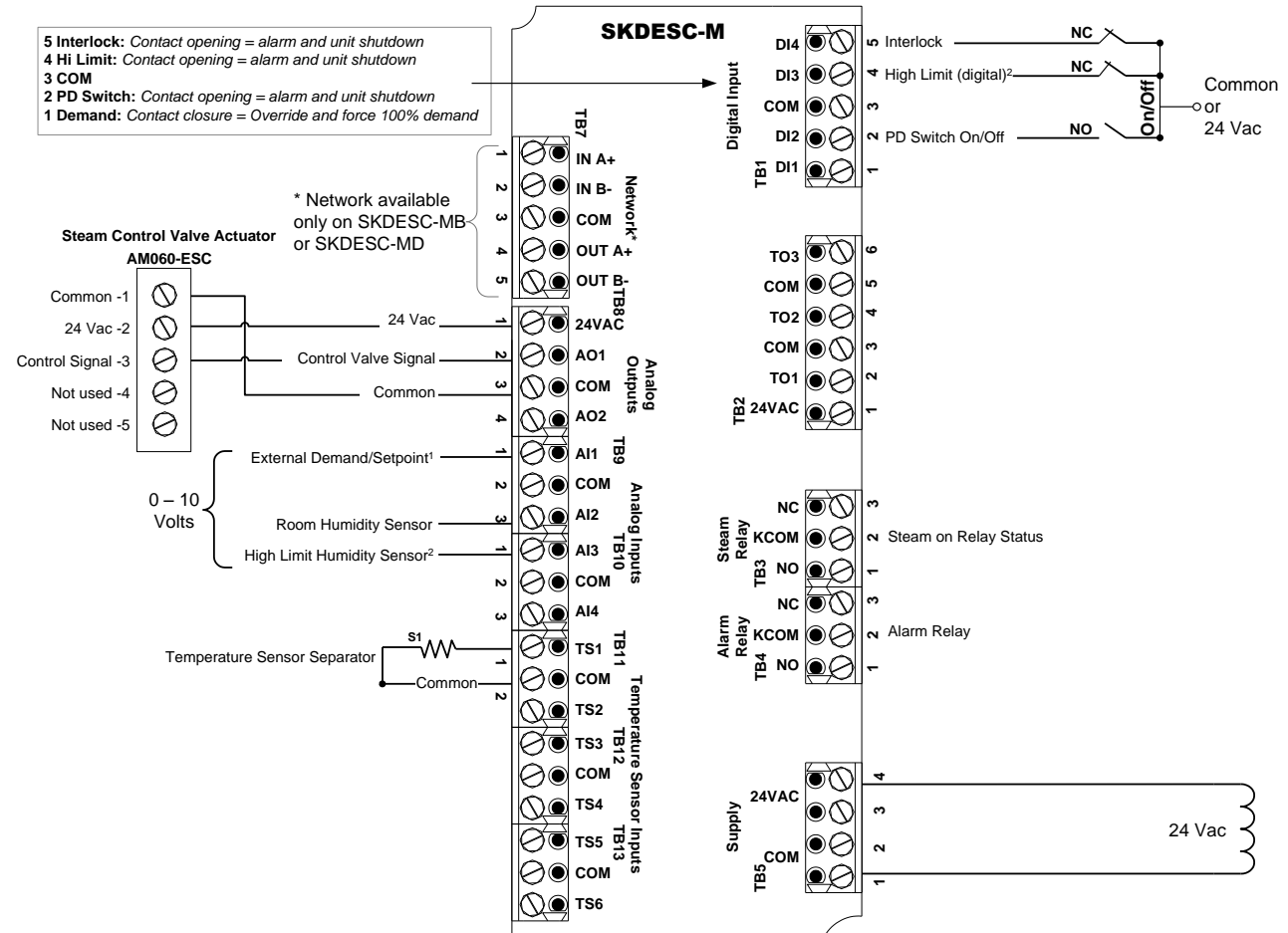

Wiring

We strongly recommend that all Neptronic products be wired to a separate grounded transformer and that transformer shall service only Neptronic products. This precaution will prevent interference with, and/or possible damage to incompatible equipment.



Step	Description	Terminal Block	
Step 7, "Control Mode" = <i>EXTERN</i>	Used for external control signal	TB9	Pin 1
Step 7 "Control Mode" = <i>INTERN</i> and Step 12, "External Humidity Setpoint" = <i>ON</i>	Used for external setpoint signal		
Step 18, "High limit sensor" = <i>DIGITAL</i>	Used for connecting high limit sensor (Digital)	TB1	Pin 4
Step 18, "High limit sensor" = <i>ANALOG</i>	Used for connecting high limit sensor (Analog)	TB10	Pin 1







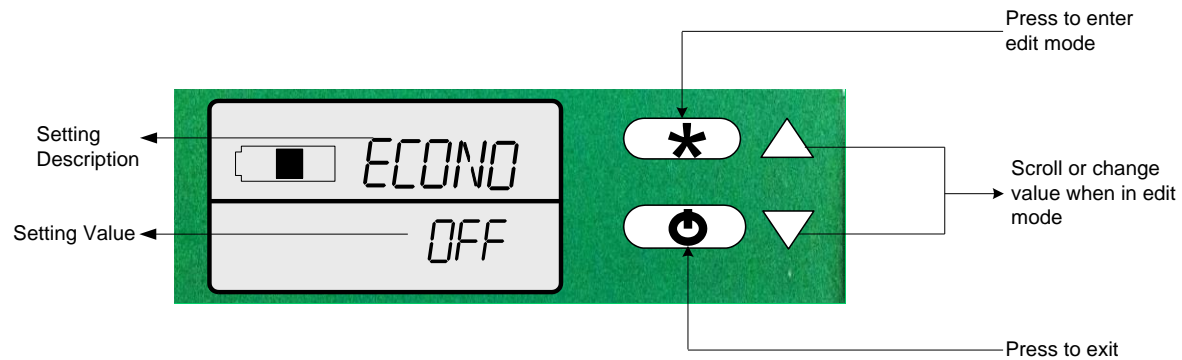

Symbols used in this manual

	Humidity
	Temperature
	Communication/Network
	Air Flow
	Timer/Clock

Programming Mode



To enter the Programming Mode, perform the following steps:

1. Press  to start and enter password (see Step 1 "enter passwrd").
2. Use the arrows buttons  or  to navigate the menu.
3. Press  to enter edit mode of the displayed value.
4. Once in edit mode, use the arrows buttons  or  to change values. Changed values are automatically saved.
5. Press  to exit edit mode of the displayed value.
6. Return to step 2 or press  to exit the mode. Auto exits after 5 minutes without any action.

1. "ENTER PASSWORD"

 Value: 637

Enter the password within 1 minute. After entering the correct password, press  to proceed. If you enter the wrong password, the controller returns to the normal operation mode and you have to repeat this step.

2. "LANGUAG"

 Default: ENG (English)
Range: ENG (English)

Select the desired language.

3. "METRIC DISPLAY UNITS"

Default: ON
 Range: ON (metric units - °C, kg H₂O/Hr), OFF (imperial units - °F, lbs H₂O/Hr)

Select the desired measurement system.

4. "ECONO MODE"

Default: OFF (econo mode deactivated)
 Range: ON (econo mode activated), OFF (econo mode deactivated)

In Econo mode, the isolation valve will be closed when there is no demand.



*Important: For correct operation, set the econo mode feature to **OFF** (econo mode deactivated).*

5. "WORKING CAPACIT IN PCT"

Default: 100%
 Range: 10 to 100%
 Increment: 5%

This option enables you to adjust the maximum demand capacity of the full system capacity in %. This percentage is a factory setting. We recommend that you do not change this value without consulting Neptronic.

6. "SEPARAT TEMPER OFFSET"

Default: 0
 Range: -10 to 10°C [-18 to 18°F]
 Increment: 0.1°C [0.1°F]

Set the desired temperature reading.

7. "CONTROL MODE"

Default: Extern
 Range: Intern, Extern, Net

Select the desired control mode from the available options.

- *If Intern is selected: the humidifier is controlled by the SKDESC-M.*
- *If Extern is selected: the humidifier is controlled by an external signal.*
- *If Net is selected: the humidifier is controlled over the network. This option is available only on SKDESC-MB and SKDESC-MD models.*

If you selected Intern or Net, go to Step 9 "network room humidity".

8. "DEMAND SIGNAL RANGE"

Default: 2-10 Vdc
 Range: 0-10 Vdc, 2-10 Vdc

Select the desired relative humidity sensor signal.

9. "NETWORK ROOM HUMIDTY"

Default: OFF
 Range: OFF, ON

This option is available only on SKDESC-MB and SKDESC-MD models. Select **ON** if you want to control the humidity over the network.

If you selected ON, go to Step 12 "Externa Humidity Setpnt".

If you selected Intern at Step 7 "Control Mode", go to Step 11 "Room humidity signal range".

10. "ROOM HUMIDTY OFFSET IN PCT"

Default: 0% RH
Range: -10 to 10% RH
Increment: 0.1% RH

Adjust the room relative humidity reading by using the offset.

11. "ROOM HUMIDTY SIGNAL RANGE"

Default: 2-10 Vdc
Range: 0-10 Vdc, 2-10 Vdc

Select the desired signal range from the available options.

If you selected Extern at Step 7 "Control Mode", go to Step 18 "High limit sensor".

12. "EXTERNA HUMIDTY SETPNT"

Default: OFF
Range: OFF, ON

Select **ON** if you want to use an external setpoint for humidity.

If you selected OFF, go to Step 14 "interna humidty setpnt in pct".

13. "SETPNT SIGNAL RANGE"

Default: 2-10 Vdc
Range: 0-10 Vdc, 2-10 Vdc

Select the desired relative humidity sensor signal. **Go to Step 15 "control dead band in pct".**

14. "INTERNA HUMIDTY SETPNT IN PCT"

Default: 40% RH
Range: 10% to 90% RH
Increment: 1% RH

Set the desired humidity setpoint in % RH.

15. "CONTROL DEAD BAND IN PCT"

Default: 2.0% RH
Range: 0% to 5% RH
Increment: 0.1% RH

Set the desired control dead band.

16. "CONTROL PROP RAMP IN PCT"

Default: 5.0%
Range: 1% to 10%
Increment: 0.1%

Set the desired control proportional ramp.

17. "CONTROL INTEGRA RAMP IN PCT"

Default: 5.0%
Range: 1% to 10%
Increment: 0.1%

Set the desired control integral ramp.

18. "HIGH LIMIT SENSOR"

- | | |
|---|---|
|  | Default: Digital (On/Off) |
| | Range: Disable, Analog, Digital (On/Off), Network |

Select the desired type of high limit sensor from the available options. This option is available only on SKDESC-MB and SKDESC-MD models.

If you selected Digital, go to Step 23 "High limit max demand in pct".

If you selected Disable, go to Step 24 "end of season delay in hr".

19. "HIGH LIMIT SETPNT IN PCT"

- | | |
|---|----------------------|
|  | Default: 80% RH |
| | Range: 10% to 90% RH |
| | Increment: 1% RH |

Set the high limit relative humidity setpoint.

20. "HIGH LIMIT PROP RAMP IN PCT"

- | | |
|---|------------------|
|  | Default: 10.0 % |
| | Range: 0% to 20% |
| | Increment: 0.1% |

Set the desired high limit proportional ramp.

If you selected Network at Step 18 "High limit sensor", go to Step 23 "High limit max demand in pct".

21. "HIGH LIMIT HUMIDTY OFFSET IN PCT"

- | | |
|--|--------------------------|
|  | Default: 0% RH |
| | Range: -10% RH to 10% RH |
| | Increment: 0.1% RH |

Adjust the relative humidity reading of the room.

22. "HIGH LIMIT SIGNAL RANGE"

- | | |
|---|---------------------------|
|  | Default: 2-10 Vdc |
| | Range: 0-10 Vdc, 2-10 Vdc |

Select the high limit signal range.

23. "HIGH LIMIT MAX DEMAND IN PCT"

- | | |
|---|--|
|  | Default: No default (information display only) |
|---|--|

Displays the actual reading of the high limit sensor.

24. "END OF SEASON DELAY IN HR"



- | | |
|---|-------------------------|
|  | Default: 100 hours |
| | Range: 100 to 250 hours |
| | Increment: 5 hours |

This option does not appear if you have selected **econo mode** at Step 4 "econo mode". Indicates that the isolation valve will be turned off after 100 hours if there is no demand.

25. "SERVICE DELAY IN HR"

 Default: 1000 hours
 Range: 400 to 1500 hours
 Increment: 100 hours

 Set the number of hours running at 100% capacity before servicing is due.

26. "SERVICE RUNTIME IN HR"

 Default: No default (information display only)

 Displays the running time in hours at 100% capacity since the last service has been performed. To reset this value to 0 and reset any associated alarms, press the edit  button and then press and hold both  and  arrow keys.

27. "RUNS WHILE SERVICE ALARM"

 Default: ACt (active)
 Range: INACt (Inactive), ACt (active)

 Select **ACt** to enable the system to run even when the servicing is due.

28. "TOTAL RUNTIME IN HR"

 Default: No default (information display only)

 Displays the running time in hours at 100% capacity.

29. "AUTO BAUD RATE"

 Default: ON
 Range: ON, OFF

 This option is available only on SKDESC-MB and SKDESC-MD models. Enable or disable Auto Baud Rate detection. When enabled, the controller automatically configures its baud rate by detecting the network speed upon connection to the network. When disabled, you must manually select the baud rate. (**go to Step 30, "baud rate"**)

30. "BAUD RATE"

 Default: No default (information display only)
 Range:
 BACnet 9.6k, 19.2k, 38.4k, 76.8k
 Modbus 9.6k, 19.2k, 38.4k, 57.6k

 This option is available only on SKDESC-MB and SKDESC-MD models. If you selected **ON** at Step 29 "auto baud rate", the baud rate is detected and displayed automatically. If you selected **OFF** at Step 29 "auto baud rate", select the baud rate value from the available options.

31. "NETWORK ADDRESS"

 BACnet

 Default: 0
 Range: 0 to 254
 Modbus
 Default: 1
 Range: 1 to 246

 This option is available only on SKDESC-MB and SKDESC-MD models. Select the desired address.

32. "ADJUST DEVICE INSTANCE"

 Default: 0153001
 Range: No, Yes

To change the device instance, select **Yes**. If you select **No**, the device instance will be modified automatically according to the MAC address.

33. "NETWORK PARITY"

 Default: None
 Range: None, Odd, Even

This option is available only on SKDESC-MD model. Select the desired parity control from the available options.

34. "NETWORK STOP BITS"

 Default: 1
 Range: 1,2

This option is available only on SKDESC-MD model. Select the desired network stop bits.

35. "NETWORK FALLBACK TIMEOUT"

 Default: 0 sec
 Range: 0 to 900 sec
 Increment: 1 sec

This option appears if you've set one of the inputs to **Net** at Step 7 "Control Mode". Set the desired network fallback timeout.

36. "NETWORK FALLBACK SETPOINT"

 Default: 0.0%
 Range: 0% to 100%
 Increment: 0.1%

This option appears if you've set one of the inputs to **Net at Step 7** "Control Mode". Set the desired network fallback setpoint.

37. "NETWORK FALLBACK COUNTER"

 Default: 0 sec
 Range: 0 to 900 sec
 Increment: 1 sec

This option appears if you've set one of the inputs to **Net at Step 7** "Control Mode". Set the desired network fallback counter.

38. "CONTROL OUTPUT SIGNAL IN MV"

Default: No default (information display only)

Displays the control valve output in mV.

39. "ISOLAT VALVE OUTPUT STATE"

 Default: No default (information display only)
 Range: INACt (closed), ACt (open)

Displays whether the isolating valve is open or closed.

40. "ALARM RELAY OUTPUT STATE"

Default: No default (information display only)
Range: INACt (closed), ACt (open)

Displays whether the alarm relay is open or closed.

41. "STEAM ON OUTPUT RELAY OUTPUT STATE"

Default: No default (information display only)
Range: INACt (closed), ACt (open)

Displays whether the steam output relay is open or closed.

42. "SEPARAT TEMPER INPUT SIGNAL IN MV"

Default: No default (information display only)

Displays the separator temperature sensor reading in mV.

43. "DEMAND INPUT SIGNAL IN MV"

Default: No default (information display only)

This option appears only if you've selected **Extern** at Step 7 "Control Mode". Displays the reading of demand in mV.

44. "ROOM HUMIDITY INPUT SIGNAL IN MV"

Default: No default (information display only)

This option does not appear if you've selected **OFF** at Step 9 "network room humidity". Displays the relative humidity reading of the room in mV.

45. "SETPNT INPUT SIGNAL IN MV"

Default: No default (information display only)

This option appears only if you've selected **ON** at Step 12 "Externa Humidity Setpnt". Displays the setpoint reading in mV.

46. "HIGH LIMIT INPUT SIGNAL IN MV"

Default: No default (information display only)

This option appears only if you've selected **Analog** at Step 18 "High limit sensor". Displays the high limit sensor reading in mV.

47. "EXTERN DEMAND INPUT STATE"

Default: No default (information display only)
Range: INACt (closed), ACt (open)

This option appears only if you've selected **Extern** at Step 7 "Control Mode". Displays if the demand is open or closed.

48. "AIR FLOW INPUT STATE"

Default: No default (information display only)
Range: INACt (closed), ACt (open)

Displays if the air flow switch is open or closed.

49. "HIGH LIMIT SWITCH INPUT STATE"

Default: No default (information display only)
Range: INACt (closed), ACt (open)

This option appears only if you've selected **Digital** at Step 18 "High limit sensor". Displays if the high limit switch is open or closed.

50. "INTRLCK INPUT STATE"

Default: No default (information display only)
Range: INACt (closed), ACt (open)

Displays if the interlock is open or closed.

51. "MICRO TEMPER"

Default: No default (information display only)

Displays whether the microcontroller temperature is in °C or °F mode.



52. "PCB TEMPER"

Default: No default (information display only)

Displays whether the PCB temperature is in °C or °F mode.

Alarms and Notifications

The following is a list of alarms and notifications displayed by the Steam Controller under different conditions. When each one of these occurs, the controller performs certain actions as described in the table. The alarm symbol,  is displayed along with the all the alarms and notifications.

Display	Description
<i>NO AIR FLOW ALARM</i>	Indicates that the air flow sensor is not detected. <ul style="list-style-type: none"> - control valve is closed - isolating valve is closed
<i>HIGH LIMIT CUTOUT ALARM</i>	Indicates that the duct humidity has exceeded the high limit level. <ul style="list-style-type: none"> - control valve is closed - isolating valve is closed - alarm relay is activated
<i>SERVICE WARNING ALARM</i>	Indicates that the servicing is due in less than 100 hours. <ul style="list-style-type: none"> - alarm relay is activated Service the unit and reset the unit by pressing the arrow keys  ,  for three seconds.
<i>SERVICE UNIT ALARM</i>	Indicates that the service is due. This alarm is displayed only if you've set the option to <i>INACT</i> at Step 27 "runs while service alarm". <ul style="list-style-type: none"> - control valve is closed - isolating valve is closed - alarm relay is activated
<i>INTER LOCK ALARM</i>	Indicates that the inter lock is activated. <ul style="list-style-type: none"> - control valve is closed - isolating valve is closed - alarm relay is activated
<i>FLOODED SEPARATE STEAM TRAP FAILURE</i>	Indicates that either the separator steam trap is flooded or the temperature is too low. <ul style="list-style-type: none"> - control valve is closed - alarm relay is activated
<i>SEPARAT TEMPER SENSOR FAILURE</i>	Indicates that the separator sensor is defective. <ul style="list-style-type: none"> - control valve is closed - isolating valve is closed - alarm relay is activated
<i>ROOM HUMIDITY SENSOR FAILURE</i>	Indicates that the room humidity sensor has failed. <ul style="list-style-type: none"> - control valve is closed - isolating valve is closed - alarm relay is activated
<i>HIGH LIMIT HUMIDITY SENSOR FAILURE</i>	Indicates that the high limit humidity sensor has failed. <ul style="list-style-type: none"> - control valve is closed - isolating valve is closed - alarm relay is activated

Power Up

Upon power up, the LCD illuminates and all segments appear for 2 seconds. The thermostat then displays its serial number, model, and revision for 2 seconds. In the Operation Mode, the information is displayed automatically in a sequence. If you wish to scroll the information quickly, use the Δ , ∇ arrow keys.

Humidity Levels

The following humidity levels are displayed:

- *HUMIDITY SETPOINT IN PCT* - Humidity setpoint in % RH
- *ROOM HUMIDITY IN PCT* - Room humidity reading in % RH
- *HIGH LIMIT HUMIDITY IN PCT* - Duct sensor reading in % RH

Control Parameters

The following control parameters are displayed:

- *CONTROL DEMAND IN PCT* - Current demand of the total system capacity measured in %
- *CONTROL OUTPUT IN PCT* - Current output of the total system capacity measured in %
- *CONTROL DEMAND* - Current demand measured in kg/hr or lbs/hr
- *CONTROL OUTPUT* - Current output measured in kg/hr or lbs/hr

Temperature Levels

The following temperature level is displayed:

- *SEPARAT TEMPER* - Separator temperature measured in °C or °F

Initial Verification



Any installation work must be carried out by suitably qualified personnel.

Installation

- Ensure that the humidifier is installed properly according to the installation manual.
- Check that steam distributors are properly installed into the ventilation duct.
- Ensure that there is no leakage on the Multi-Steam™ SD/HD piping.

Electrical

- Confirm that 24Vac is present between tab 1&4 of terminal block TB5 on the SKDESC-M Steam Controller.

Drain if Required

- If there is a steam trap on the header, confirm that the drain piping is properly connected with a pitch of at least $\frac{1}{4}$ " (6.5mm) per foot (300mm). There is no header on the single tube channel configuration and therefore there is no steam trap on the header.

Steam Supply

- Ensure that the steam supply is on.
- Ensure that there is no leakage on the steam piping when the steam supply is on.

Controls

- Ensure that a high limit duct humidistat is installed, properly connected to the SKDESC-M and the setpoint is properly adjusted.
- Verify that the room humidistat or returned air duct humidistat is installed, properly connected to the SKDESC-M, and the setpoint is properly adjusted.
- Turn on the power at the disconnect switch.
- Confirm the control setup of the humidifier. The humidifier is factory set with EXTERNAL control setup, which means that the humidity demand is controlled by the room or duct humidistat.
- Ensure that the type of signal (0-10 Vdc, 2-10 Vdc or 4-20 mA) of the humidistat corresponds to the type set in the humidifier control set-up.

Start-Up Procedure

Start-up

Proceed to start-up the humidifier as follows:

- Make sure that the steam is supplied to the Multi-Steam™ SD/HD.
- Switch on the SKDESC-M.
- Make sure that there is no alarm. If the A6 alarm stays on, it means that the steam does not reach the separator or there is a problem with evacuating the condensate from the separator steam trap.
- Wait for a call for humidity or create it by setting the SKDESC-M “Control Mode” to Internal (step #7), and the “External Humidity Setpoint” to OFF (step #12). Then, adjust the setpoint to a higher value than the room humidity reading (operation mode B).
- Once the temperature is high enough, the control valve will open slowly.
- The start-up is complete and the humidifier is now functional.

Safety Test

- Check for steam or condensate leakage while the humidifier is in operation.
- Check the location of the airflow switch in the system and its operation by stopping the fan or by disconnecting the air pressure connection. With no air movement in the duct, the SKDESC-M will automatically stop the humidifier by closing the control valve.

Reset the Setpoint and Control Mode

- If the humidity setpoint is controlled by the SKDESC-M, reset the setpoint to the desired relative humidity % (set #20) as suits the room.
- If the humidity setpoint is controlled by another device than the SKDESC-M (typically by the BMS), set the internal control signal to OFF.

End

- The humidifier is ready for normal operation.



neptronic®

400 Lebeau blvd, Montreal, Qc, H4N 1R6, Canada

www.neptronic.com

Toll free in North America: 1-800-361-2308

Tel.: (514) 333-1433

Fax: (514) 333-3163

Customer service fax: (514) 333-1091

Monday to Friday: 8:00am to 5:00pm (Eastern time)